

# KME ITALY SpA

Via della Repubblica, 257 - 55051 Fornaci di Barga (Lucca) - Tel. 0583 701.413-412 - Fax 0583 701406  
[www.kme.com](http://www.kme.com) - [mic@kme.com](mailto:mic@kme.com)

## 電線索頭系列的 RAD ISO 和 RAD GAS Used for termination of Mineral Insulated Cables MICO®



### 1 一般信息

電線索頭系列的 RAD ISO 和 RAD GAS 符合指令 2014/34 /歐盟和 IECEx 策劃製造是根據下面的歐洲和 IEC 標準：

- EN IEC 60079-0 : 2018 · EN 60079-1 : 2014 · EN IEC 60079- 7 : 2015+A1:2018 · EN 60079-31 : 2014;
- IEC 60079-0 : 2017 · IEC 60079-1 : 2014 · IEC 60079-7 : 2015 · IEC 60079-31 : 2013.

電線索頭組件的終端是用於礦物絕緣銅電線 ( Mineral Insulated Copper Cable 簡稱為 MICO 一般稱為銅皮線 ) · 亦是附合歐洲標準 EN60702-2 : 2002 +A1 : 2015.







執行:

安裝	1 區 (氣體)	21 區 (灰塵)
保護類型	 II 2G Ex eb IIC Gb II 2G Ex db IIC Gb	 II 2D Ex tb IIIC Db
防水度數 (IP)	IP 65	
ATEX 證書 (*)	IMQ 17 ATEX 027 X	
IECEx 證書(*)	IECEx IMQ 19.0001X	
服務溫度	-20°C ÷ +250°C	
環境溫度	-20°C ÷ +70°C	





(\*) "X" 證書表明電線接頭是適用於固定裝置。

### 2 可能遇見的風險

在這裡是列出可能遇見的風險事件 · 多為不正確使用的交通運輸 · 安裝或維護在於銅皮線 (MICO®) 的終端電線連接索頭。

- 觸電 由於不正確執行的終端連接 · 將其中的一段對地保護。
- 切割/剪切/穿刺/灼傷 過程中手動操作所需的安裝和終端電線連接索頭的執行。
- 一般危險 是安排了非訓練有素的人員或不正確裝配 · 執行運送 · 安裝 · 或維護而引起危險。
- 接觸化學品 

### 3 安全說明

- 慣常的要求是防護磨損裝備在交通 · 安裝和使用上 (如手套, 護目鏡, 頭盔, 鞋)。
- 必須只有合格人員進行安裝和維護操作。
- 電氣設備或系統配置在安裝和維護操作進行時, 必須在電源電壓已斷開連接。

- 在任何情況下操作化學劑, 請按相關材料安全數據文件指示 (MSDS 的)。
- 國家安全規則和事故預防法規, 指定作為本文檔中, 必須嚴格遵守。
- 以下指令必須嚴格遵守。
- 不允許更換或修理電線索頭。
- 必須使用 KME 之配件。
- 銅皮線 MICO®只可使用 KME 終端索頭密封工具包, 在執行的終端接駁要遵循 MICO®電線安全指示, 請參閱在密封試劑包裝盒內的單張才可使用。

### 4 預期使用

電線索頭適用於銅皮線 MICO®配合 Ex d 和 Ex e 防爆箱並必須使用合適的大小螺紋孔 (如使用無開孔與不合適的螺母螺紋將沒有保證)。  
 電線索頭設計是專為各類型防爆保護 RAD ISO 和 RAD GAS, Ex db IIC 斷路器和增加各類型的安全保護 Ex eb IIC 斷路器。  
 電線索頭認證上述爆炸系列, 亦認證保護類型 Ex tb IIIC 存在危險可燃灰塵。  
 IP 65 度是保證沒有使用墊片。

### 5 組裝說明

電線索頭用於銅皮線安裝到機箱 (連接盒), 它們是由壓縮圈、佛蘭蓋、佛蘭頭組成為一個整體。

錐形氣體螺紋頭 (RAD GAS) EN10226 (ex UNI ISO 7-1)		等距圓柱形螺紋頭 (RAD ISO) ISO 262 (UNI 4535)	
Ø D	Lenght L	Ø D	Lenght L
1/2"	15,40	M 20x1,5	11
3/4"	15,40	M 25x1,5	12
1"	19,70	M 32x1,5	12
1-1/4"	19,70	M 40x1,5	12

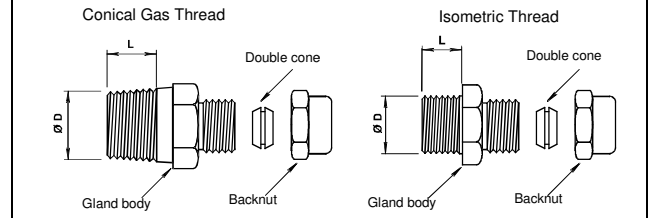
為正確完成安裝過程和執行終端, 其中的電線索頭是一個重要組件, 請按照指引 “銅皮線使用手冊”(MICO®) 和終端使用”可在網站上 [www.kme.com](http://www.kme.com) 或通過電子郵件 [mic@kme.com](mailto:mic@kme.com)。本文檔顯示所有 KME 配件需要完全執行詳細的使用程序, 運輸, 安裝和銅皮線索頭終端接駁 (MICO®), 跟隨著技術數據, 提示和有關詳細的插圖執行。

### 執行終端和電線索頭安裝

把銅皮線鋸至適當長度, 將剝皮工具套進線口, 用手輕旋夾口螺絲至沒有虛位 (切忌用力過大)。

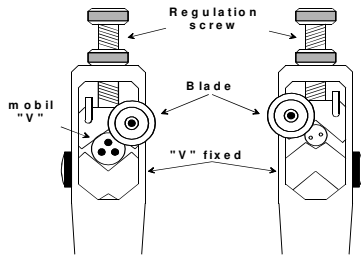

手握工具順時針旋轉，同時向內輕推，如皮屑太長，用鉗除掉。到足夠長度，用 V 形位置夾緊以限制工具繼續進刀，旋轉一週後可得平滑之 90 度切口。

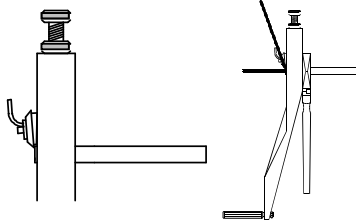

清潔導體並將電線接頭配件：佛蘭蓋、壓縮圈、佛蘭頭、銅杯蓋等順序套上。

在配件/線身連接情況下預留虛位作為填補是必要的，以免造成電線破損。在 ATEX / IECEx 應用的情況下索頭/連接箱必須保證符合以下條件。

- 帶螺紋佛蘭頭 Ex d：RAD ISO 與 RAD GAS 連接電線索接頭必須至少保證 5 個完整的螺紋嚙合，並且最小厚度外皮的尺寸必須大於或等於 8 毫米。
  - 接合必須保證把蓋掩穿過導體並套進杯口，然後拉出約 35 毫米，以糾正及固定導線。
- 防止線身移動用合適的索頭配件固定在線身上。

將金屬索頭之壓縮圈、佛蘭頭、銅杯、佛蘭蓋確保完全密封收緊後，並由安裝人員負責，最小收緊手扳，如以下表中數據報告。

索頭系列	索頭類型/尺寸	最小收緊扭矩 [Nm]
RAD ISO	20	18
	25 及 25T	18
	32 <i>只適用於 12H 電線</i>	40
	32T	40
	32 <i>電線 1H, 2H e 4H</i>	45
	ISO 40 <i>(1H400 除外)</i>	110
	ISO 40 1H400	150
RAD GAS	1/2"	18
	3/4"	18
	1"	36
	1 1/4"	36

注意：“T”表示用於銅皮線的 ISO 電線密封套，密封件配有接地線。

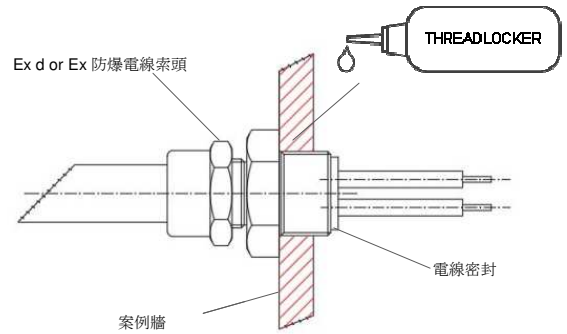

請按以下步驟完成線口封裝，將自攻銅杯蓋擰在電纜護套上，套進線口後 銅杯用夾具固定，以順時針旋進攻牙，將孔的內部放在銅護套上。

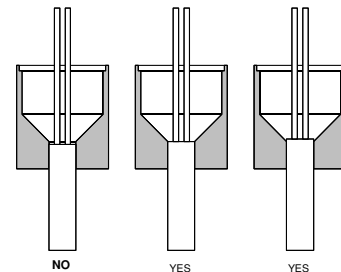

操作過程中將銅杯內氧化鎂粉末振掉（切忌口吹）。

用 500 Vcc 的 Megger 檢查電線絕緣電阻是否高於 100 MΩ；然後將密封劑倒入銅杯內。

用鉗子拉動導體並用密封劑填滿銅杯後，然後用封口工具套進銅杯並旋轉扳手，將銅杯蓋掩榨緊，將佛蘭移前，套入銅杯。

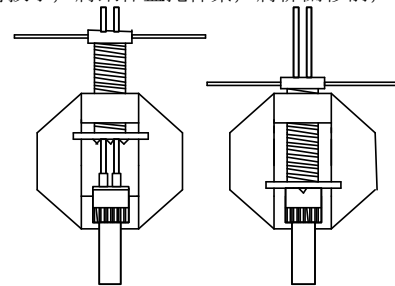

切掉過長度的套管，先穿入錐形管套，再進行及完成線口封裝步驟後，用割出之膠皮套著光身銅皮部分。此時，線口封已準備好用割出之膠皮套著光身銅皮部分，用 PVC 膠布包好，把膠套推前完成，以便隨後收緊接合在防爆 Ex 箱中。

要進行銅皮線口封裝與固定，您需要以下組件（當然還有銅皮線）：導體、佛蘭蓋、壓縮圈、佛蘭頭、銅杯蓋、膠套，最後低煙無滷膠套（如果電線需要低煙無滷），及以下工具：剝離器、備用刀片、壓接工具。

檢查 MICO®電纜的工具尺寸通用手冊或 MICO®電纜安裝的技術手冊。

## 6 拆除和棄置

在進行最終拆除之前，有必要將可能造成污染的各個部件分開，選擇材料以便於回收，並指定單獨處理。

# KME ITALY SpA

Via della Repubblica, 257 - 55051 Fornaci di Barga (Lucca) - Tel. 0583 701.413-412 - Fax 0583 701406  
[www.kme.com](http://www.kme.com) - [mic@kme.com](mailto:mic@kme.com)

## CABLE GLANDS SERIES RAD ISO AND RAD GAS *Used for termination of Mineral Insulated Cables MICO®*



### 1 GENERAL INFORMATION

Cable glands series RAD ISO and RAD GAS compliant with Directive 2014/34/EU and the IECEx Scheme are manufactured according to the following European and IEC standards:

- EN IEC 60079-0:2018, EN 60079-1:2014, EN IEC 60079-7:2015+A1:2018, EN 60079-31:2014;
- IEC 60079-0:2017, IEC 60079-1:2014, IEC 60079-7:2015, IEC 60079-31:2013.

The cable glands, as components of the terminations for mineral insulated cables, also meet the European standard EN 60702-2:2002+A1:2015.







Execution:

Installation	Zone 1 (gas)	Zone 21 (dusts)
Protection Types	 II 2G Ex eb IIC Gb II 2G Ex db IIC Gb	 II 2D Ex tb IIIC Db
IP degree	IP 65	
ATEX Certificate (*)	IMQ 17 ATEX 027 X	
IEC Ex Certificate (*)	IECEX IMQ 19.0001X	
Service Temperature	-20°C ÷ +250°C	
Ambient Temperature	-20°C ÷ +70°C	

(\*) "X" in the certificates indicates that the cable glands are suitable for fixed installations..

### 2 RESIDUAL RISKS

Here is a list of residual risks in the event of incorrect transport, installation, use or maintenance of cable glands used for termination of Mineral Insulated Cable (MICO®).

- **Electrocution** due to incorrect execution of the termination, putting one of the phases on the earth sheath. 
- **Cutting / Shearing / Puncture / Burns** during manual operations required for the installation and the termination's execution.   
- **Generic hazard** for transportation, installation, use or maintenance performed by unqualified and non trained or incorrectly equipped personnel. 
- Contact with **chemicals**. 

### 3 SAFETY INSTRUCTIONS

- Always wear PPE required for transportation, installation and use (goggles, gloves, helmets, shoes). 
- Installation and maintenance operations must be carried out only by qualified personnel.
- Installation and maintenance operation must be carried out only after the mains voltage has been disconnected from electrical apparatus or system to which the cable glands are fitted.
- In case of manipulation of chemical agents, follow the instructions of the related material safety data sheet (MSDS).

- The national safety rules and accident prevention regulations, specified as in this document, must be strictly observed.
- The following instruction must be strictly adhered to.
- Changes or repairs to the cable glands are not allowed.
- Only KME spare parts must be used.
- Use only KME seal kits for termination of MICO® cables. For the safety instructions to be followed in the execution of the termination of MICO® cables, refer to the leaflet available in the seal kit packages.

### 4 INTENDED USES

The cable glands are suitable for inserting mineral insulated cables MICO® into Ex d and Ex e enclosure by means of threaded holes of suitable size (the use with enclosure with not-threaded holes and the use of counter-nuts is NOT guaranteed).

The cable glands RAD ISO and RAD GAS are designed for the type of protection flameproof Ex db IIC and for the type of protection increased safety Ex eb IIC.

The cable glands of the series above mentioned are also certified against the risk of explosion for the presence of combustible dust, protection type Ex tb IIIC.

IP 65 degree is guaranteed without the use of gaskets.

### 5 ASSEMBLING INSTRUCTIONS

The cable glands are used to insert the mineral insulated cable into enclosures (junction boxes) they consist of a body, a double cone and a brass backnut.

Conical (RAD GAS) EN10226 (ex UNI ISO 7-1)		Isometric cylindrical (RAD ISO) ISO 262 (UNI 4535)	
Ø D	Lenght L	Ø D	Lenght L
1/2"	15,40	M 20x1,5	11
3/4"	15,40	M 25x1,5	12
1"	19,70	M 32x1,5	12
1-1/4"	19,70	M 40x1,5	12

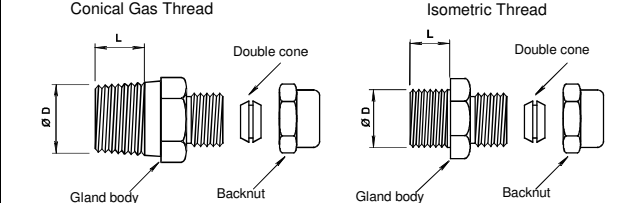
For the correct and complete installation procedure and execution of the terminations, of which the cable glands are a component, follow only what is reported extensively in the "**Instruction Manual- Mineral Insulated Cable (MICO®) and their Terminations**" available on the website [www.kme.com](http://www.kme.com) or by e-mail at [mic@kme.com](mailto:mic@kme.com). This document shows all KME accessories required and detailed procedures to fully execute transportation, installation and termination of Mineral Insulated Cable (MICO®), accompanied by technical data, tips and detailed illustrations about.

#### Termination execution and cable glands installation

Cut the end of the cable by a small saw; place the stripper on the cable and tighten it: the blade must be in contact with the copper outer sheath and the V shaped clamp must be tightened on the cable by its screw, so to let the tool spin round with the cable without stopping it.

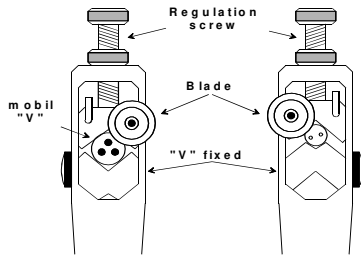

Start rotating the tool pushing it towards the inner part of the cable; avoid the rolling up of the copper shaving on the conductors, fixing it on the suitable hook.  
When you have stripped enough copper sheath, you can insert the pliers to cause the drop of the copper shaving.

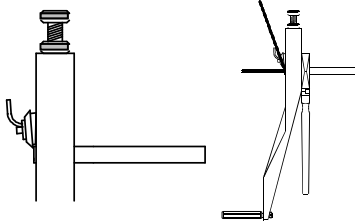

Clean the conductors and insert cable gland components in the sequence: backnut, double cone and body.  
In case that the fitting/housing coupling is subjected to vibrations it is necessary, in order not to cause breakage of the cable, to make a compensation bend in the vicinity of the housing. In case of ATEX/IECEx applications for the cable gland/enclosure jointing the following conditions must be guaranteed:

- Enclosure with threaded entries Ex d: jointing with both RAD ISO and RAD GAS cable glands must guarantee that at least 5 complete threads are engaged, and the minimum thickness of the enclosure must be greater than or equal to 8 mm.
- Enclosure with threaded entries Ex t: jointing with RAD ISO cable glands must guarantee that at least 5 complete threads are engaged, while coupling with RAD GAS cable glands must guarantee that at least 3,5 threads are engaged.

To prevent loosening of the body with the case, apply a suitable threadlocker to at least on thread.

The seal is guaranteed by the full tightening of the metal double cone through the backnut and it is entrusted to the care of the installer. The minimum tightening torques are reported in the table below.

Gland Series	Gland Type/Size	Minimum Tightening Torque [Nm]
RAD ISO	20	18
	25 and 25T	18
	32	40
	Only for 12H cables	
	32T	40
	32	45
	Cables 1H, 2H e 4H	
RAD GAS	ISO 40	110
	(except 1H400)	
	ISO 40 1H400	150
	ISO 40T	45
	1/2"	18
	3/4"	18
	1"	36
1 1/4"	36	

**Note:** The "T" identifies ISO cable glands for mineral insulated cables with seals equipped with ground wire.

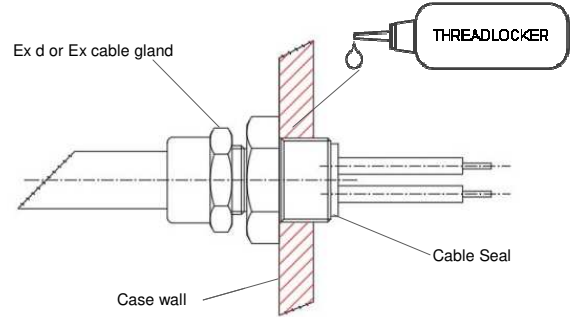

Proceed as follows to complete the termination. Screw the self threaded brass pot on the cable sheath, placing the inner part of the hole on the copper sheath.

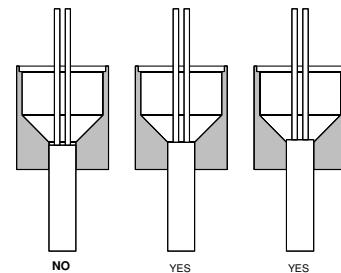

Remove from the brass pot the Magnesium Oxide shattered during previous operation.

Check with a Megger, at 500 Vcc, that cable insulation resistance is higher than 100 MΩ; then pour the sealant inside the brass pot.

After pulling the conductors by a pliers and filled the brass pot with sealant place the stub cap as close as possible to the brass pot, then start to press it onto the brass pot using the suitable screw tool.

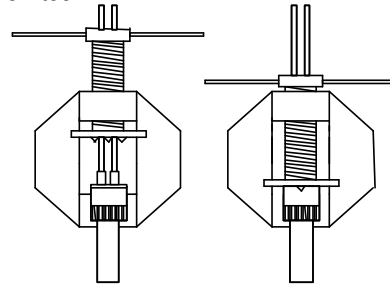

Cut some lengths of sleeving and, after removing eventual exceeding sealant, place them on the stub cap.

At this point the seal is ready to be inserted in the cable gland body and for subsequent operation of introduction and tightening in Ex box.

To make a termination, you need the following components (in addition to the cable, of course): seal, gland, sealant, eventual LSF shroud (if cable is LSF required), and the following tools: stripper, spare blades, crimping tool.

Check MICO® cables general brochure for tools dimension or technical manual for MICO® cables installation.

## 6 UNINSTALLING AND DISPOSAL

Before proceeding to final dismantling it is necessary to separate the various parts that could cause pollution, make a selection of materials in order to facilitate recycling, to earmark separate disposal.